

# PREZENTACE TVAROVANÝCH PLECHŮ - VÝKRESY

KERAKRYT - vstupní š. 497 mm

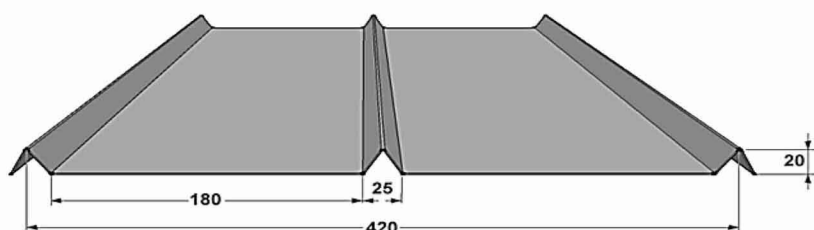

KERAL, KPTR 1017 - vstupní š. 1000 mm

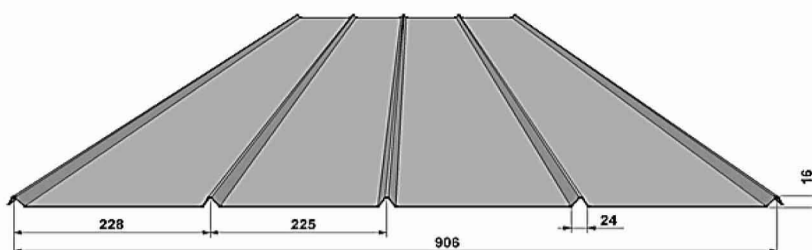

KPTR 40/184 - vstupní š. 1000 mm

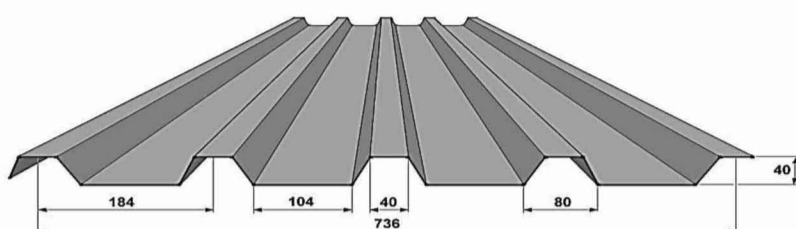

KPTR 13/94 - vstupní š. 1000 mm

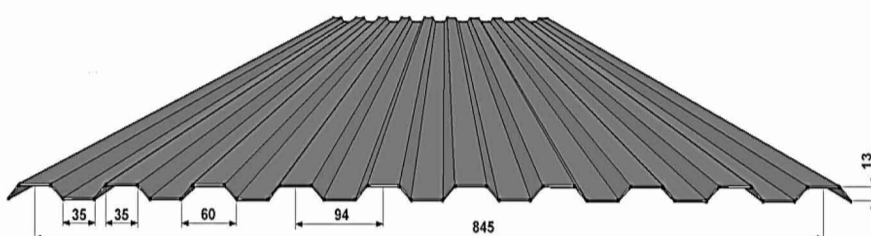

KPTR 13/94 - vstupní š. 1200 a 1250 mm

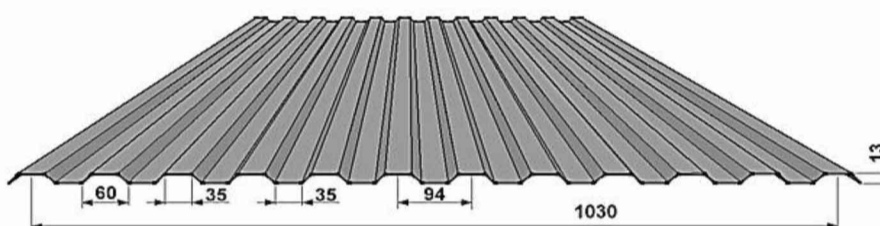

KPTR 35/207 - vstupní š. 1000 mm

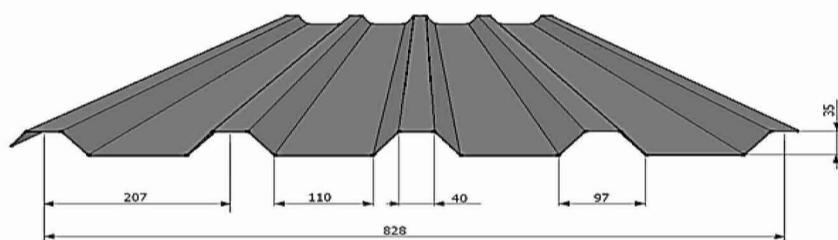

KPTR 35/207 - vstupní š. 1250 mm

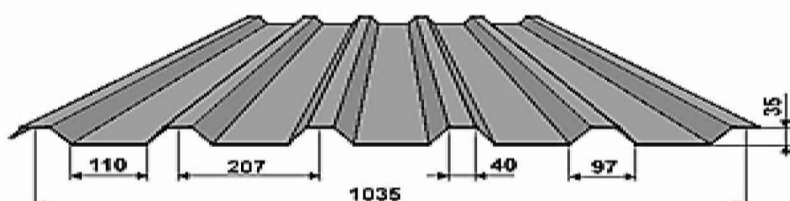

KPTR 13/94S (s prolisem špičatým)

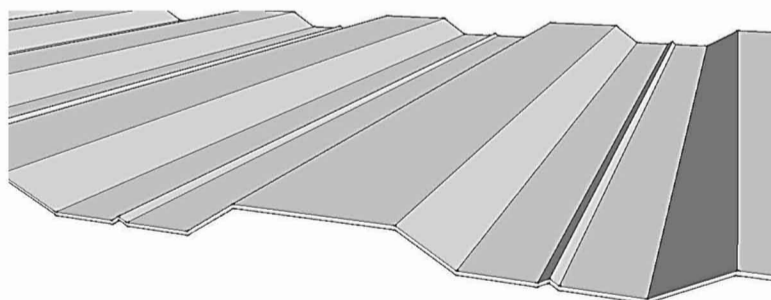

KPTR 35/207S (s prolisem špičatým)

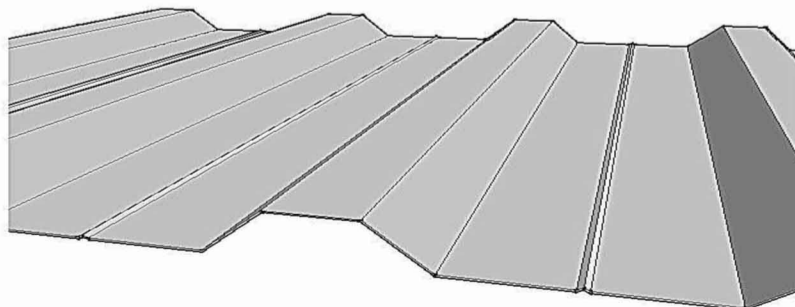

KPTR 35/207F (s prolisem plochým)

